

U-PRO MANUAL

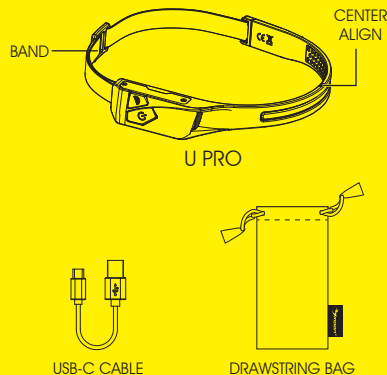

The light is locked for shipment, refer to OPERATION instruction to unlock. Read this manual carefully before using and keep for future reference. Visit www.moon-sport.com for manual updates.

CONTENTS



USB-C CABLE

DRAWSTRING BAG

OPERATION

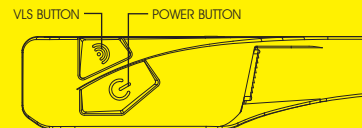

- ON / OFF : Press / Press and hold 0.5s
- MODE SELECT : Click
- BOOST MODE : Double click
- BEAM SELECT : Click
- STEADY / FLASH : Double click
- LOCK / UNLOCK : 1. Power off
2. Press and hold 5s
3. BEEP! when locked / BEEP! BEEP! when unlocked

* Lock system: Lock the light to prevent accidentally turned on.
* Mode memory: The light resumes previous mode upon next usage.

VARIABLE LUMEN SYSTEM

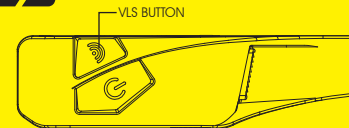

- Select desired mode.
- Press and hold to set lumen.
- Release when reaching desired lumen.

* Light flashes once when reaching the MAX or MIN lumen level.

- * Restore default setting:
- Power off
 - Press and hold 8s
BEEP! BEEP! BEEP! when finished.

* Mode memory: The light resumes previous VLS setting upon next usage.

SOUND ALARM SYSTEM



SAS beeps when battery is low.

- 50% - beep! (1time)
- 25% - beep! beep! (every 10mins)
- 10% - beep! beep! beep! (every 10mins)

CHARGING

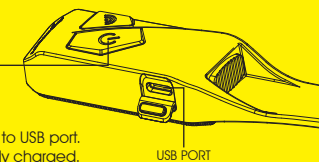
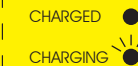

- Power off.
- Plug USB cable to USB port.
- Unplug after fully charged.

* Do not charge over 5V.
* Keep away from flammable objects while charging.

RUNTIME



	BOOST	MODE1	MODE2
DEFAULT LUMEN	500	400	100
H-MIN	1:10	1:30	6:00
VLS LUMEN	-	400-10	400-10
H-MIN	-	1:30-52:00	1:30-52:00



	BOOST	MODE1	MODE2
DEFAULT LUMEN	500	300	70
H-MIN	1:10	2:00	8:00
VLS LUMEN	-	300-5	300-5
H-MIN	-	2:00-102:00	2:00-102:00



	BOOST	MODE1	MODE2	FLASH	STEADY FLASH	SOS
DEFAULT LUMEN	500	200	50	10	20	-
H-MIN	1:10	3:00	11:00	204:00	68:00	66:00
VLS LUMEN	-	200-5	200-5	200-5	200-5	-
H-MIN	-	3:00-108:30	3:00-108:30	17:00-330:00	20:00-68:00	-



	BOOST	MODE1	MODE2
DEFAULT LUMEN	500	6	3
H-MIN	1:10	21:30	40:00
VLS LUMEN	-	6-1	6-1
H-MIN	-	21:00-165:00	21:00-165:00

▲ Use the SOS sign for real emergency only!

BAND INSTALLATION

STEP.1

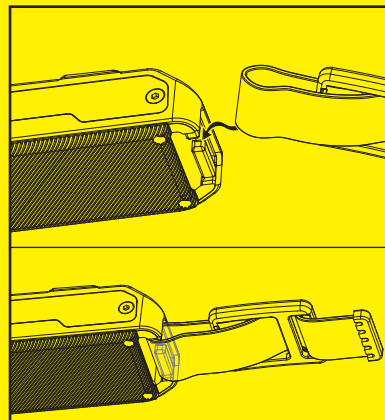

STEP.2

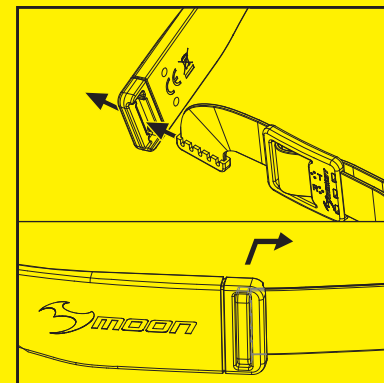

CENTER ALIGN

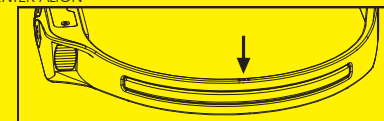

WARNING

Understand country lighting laws and regulations before use. Do not shine light directly into eyes. Do not submerge the light into water. Keep light in cool and dry place when storing. Fully recharge the light at least every 3 months during storage. Do not place the band around neck to prevent strangulation. Do not twist the COB.



WARRANTY

MOON lights are covered by a ONE YEAR LIMITED WARRANTY from the date of purchase. This warranty covers the defects in material and workmanship only with proof of purchase. Please contact original dealer for warranty service. For lights bought on MOON website, please contact cs@moon-sport.com for help.

ONLINE WARRANTY REGISTRATION
Visit www.moon-sport.com for online warranty registration.