

# U-mini plus MANUAL

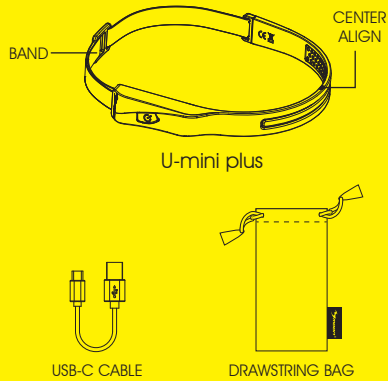

The light is locked for shipment, refer to OPERATION instruction to unlock. Read this manual carefully before using and keep for future reference. Visit [www.moon-sport.com](http://www.moon-sport.com) for manual updates.

## CONTENTS



## OPERATION

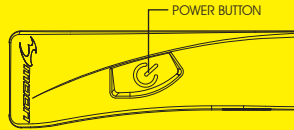

- ON / OFF : Press / Press and hold 0.5s  
 MODE SELECT : Click   
 STEADY / FLASH : Double click   
 LOCK / UNLOCK : 1. Power off  
 2. Press and hold 5s  
 3. BEEP! when locked / BEEP! BEEP! when unlocked

- \* Lock system: Lock the light to prevent accidentally turned on.
- \* Mode memory: The light resumes previous mode upon next usage.

## VARIABLE LUMEN SYSTEM

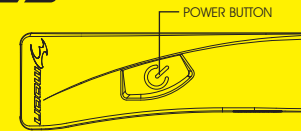

1. Select desired mode.
2. Press and hold to set lumen.
3. Release when reaching desired lumen.

\* Light flashes once when reaching the MAX or MIN lumen level.

- \* Restore default setting: 1. Power off  
 2. Press and hold 8s  
 BEEP! BEEP! BEEP! when finished.

\* Mode memory: The light resumes previous VLS setting upon next usage.

## SOUND ALARM SYSTEM



SAS beeps when battery is low.

- 50% - beep! (1time)
- 25% - beep! beep! (every 10mins)
- 10% - beep! beep! beep! (every 10mins)

## CHARGING

- CHARGED ●
- CHARGING ●

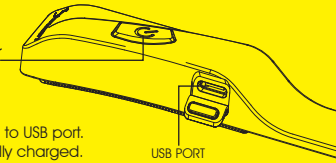

1. Power off.
2. Plug USB cable to USB port.
3. Unplug after fully charged.

- \* Do not charge over 5V.
- \* Keep away from flammable objects while charging.

## RUNTIME

●●●●● COB

	MODE1	MODE2	MODE3	FLASH	STEADY FLASH	SOS
DEFAULT LUMEN 	200	100	5	10	20	-
H:MIN 	1:30	3:00	51:30	105:30	37:30	32:00
VLS LUMEN 	200-5	200-5	200-5	200-5	200-5	-
	1:30-51:30	1:30-51:30	1:30-51:30	7:40-156:00	10:00-37:00	-

Use the SOS sign for real emergency only!

## BAND INSTALLATION

STEP.1

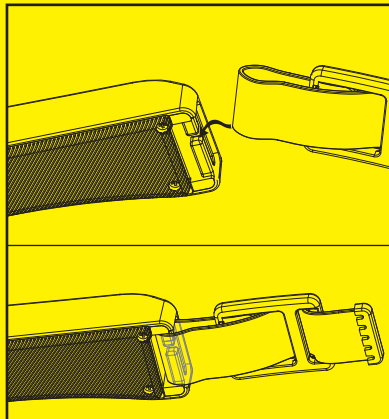

STEP.2

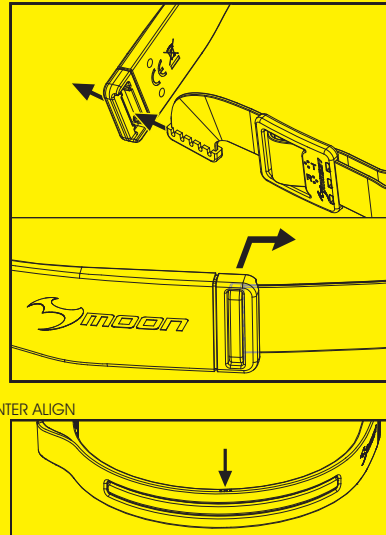

## WARNING

- Understand country lighting laws and regulations before use.
- Do not shine light directly into eyes.
- Do not submerge the light into water.
- Keep light in cool and dry place when storing.
- Fully recharge the light at least every 3 months during storage.
- Do not place the band around neck to prevent strangulation.
- Do not twist the COB.

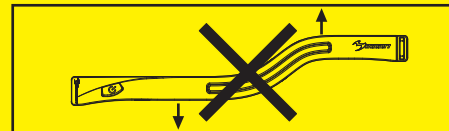

## WARRANTY

MOON lights are covered by a ONE YEAR LIMITED WARRANTY from the date of purchase. This warranty covers the defects in material and workmanship only with proof of purchase. Please contact original dealer for warranty service. For lights bought on MOON website, please contact [cs@moon-sport.com](mailto:cs@moon-sport.com) for help.

ONLINE WARRANTY REGISTRATION

Visit [www.moon-sport.com](http://www.moon-sport.com) for online warranty registration.