



The light is locked for shipment, refer to OPERATION instruction to unlock. Read this manual carefully before using and keep for future reference. Visit www.moon-sport.com for manual updates.



HELIX LITE MANUAL

CONTENTS

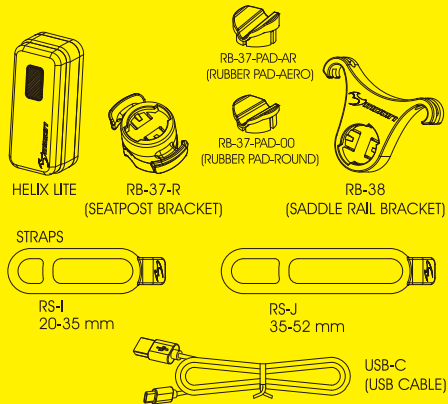

Optional accessories:
RB-39 (BELT CLIP)

OPERATION

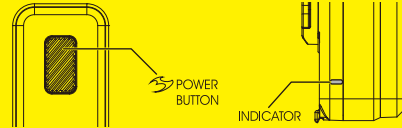

- ON / OFF : Press 1s
- MODE SELECT : Click
- STEADY / FLASH : Double Click
- LOCK/UNLOCK : 1, Power off
2, Press 6s: Locked FLASH 2 TIMES
Unlocked FLASH 2 TIMES

* Lock system: Lock the light to prevent accidentally turned on.
* Mode memory: The light resumes previous mode upon next usage.

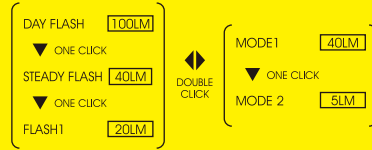

VARIABLE LUMEN SYSTEM

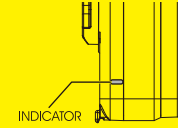

1. Select desired mode.
2. Press and hold to set lumen.
3. Release when reaching desired lumen.

* Light flashes twice when reaching the MAX or MIN lumen level.

- * Restore default mode: 1. Power off
2. Press 10s: FLASH 3 TIMES

RUNTIME

	ANSI FL1	DAY FLASH	STEADY FLASH	FLASH1	MODE1	MODE2
DEFAULT	LUMEN	100	5 + 40	20	40	5
	H:MIN	15:30	8:00	16:00	1:50	11:30
	VLS LUMEN	100-10	100-10	100-10	40-5	40-5
H:MIN	15:30-54:00	5:30-10:30	4:00-30:00	1:50-11:30	1:50-11:30	

DEPENDS ON MODE LUMENS

AUTO SAFE MODE



Quick Flash

To preserve battery when power is low, the light will enter safe mode with less light output for extra **45mins**. Safe mode cannot be override. Recharge battery for maximum performance.

MOUNTING

SEATPOST MOUNTING

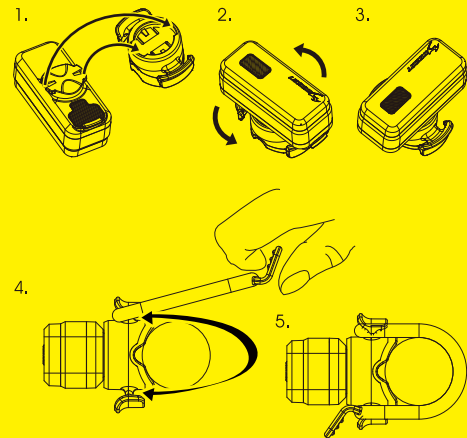

MOUNTING

SADDLE RAIL MOUNTING

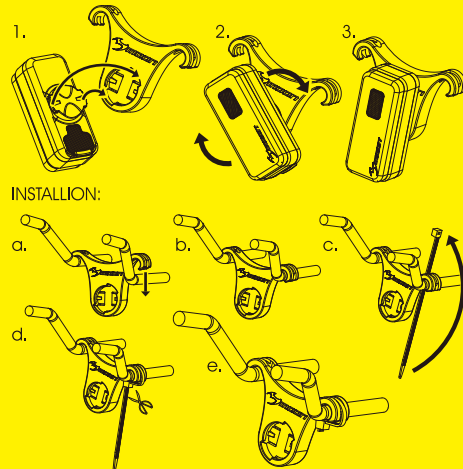

MOUNTING

BELT CHIP (OPTIONAL) MOUNTING

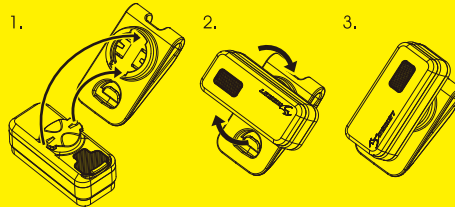

CHARGING

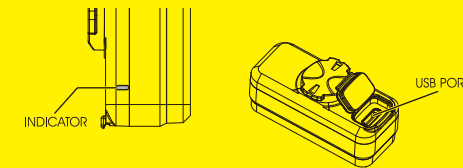

- CHARGING
1. Power off
 2. Plug USB-C cable to USB-C port
 3. Unplug after fully charged

- * Do not charge over 5V.
- * Keep away from flammable objects while charging.

INDICATOR

- Low battery (Slow Flash)
- Auto safe (Quick Flash)
- Charging
- Fully Charged * 3:00hrs

WARNING

- Understand country lighting laws and regulations before use.
- Do not shine light directly into eyes.
- Do not mount near wireless computer.
- Do not blind the oncoming vehicles. Always adjust the angle downward.
- Do not submerge the light into water.
- Keep light in cool and dry place when storing.
- Fully recharge the light at least every 3 months during storage.

WARRANTY

MOON lights are covered by a ONE YEAR LIMITED WARRANTY while MOON batteries are covered by 120 days warranty from the date of purchase. This warranty covers the defects in material and workmanship only with proof of purchase. Please contact original dealer for warranty service. For lights bought on MOON website, please contact cs@moon-sport.com for help.

ONLINE WARRANTY REGISTRATION
Visit www.moon-sport.com for online warranty registration.