

# MIZAR

MANUAL

Read this manual carefully before using and keep for future reference. Visit [www.moon-sport.com](http://www.moon-sport.com) for manual updates.

## CONTENTS

MIZAR  
Magnetic mount RB-29-W  
Straps  
- RS-G for  $\phi$ 20-35mm  
- RS-H for  $\phi$ 35-52mm

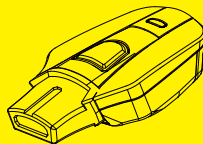

## RUNTIME

	Mode 1	Mode 2	FL1	FL2	DAY FL
LUMEN	20	40	20	50	100
H:MIN	8:00	4:00	70:00	40:00	30:00
1M LUX	11.9	23.5	-	-	/
2M LUX	3.2	5.8	-	-	/



## OPERATION

1. Press to power on.

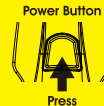

2. Press to choose modes in cycle.

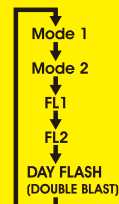

3. Press 1 sec to power off.

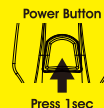

\*\*\*With Mode Memory Function:

the light resumes previous mode upon next usage.

DAY FLASH MODE MEMORY



MIZAR MAGNETIC STRAP STRAP  
MOUNT  $\phi$ 20-35MM  $\phi$ 35-52MM



## LOW BATTERY & CHARGING INDICATOR

Low battery indicator

- \* Solid blue

Charging indicator

- \* Solid blue - charging
- o Off - charged

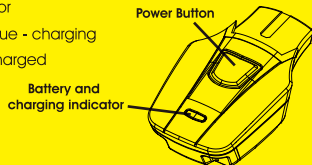

## BATTERY CHARGING

Take off the rubber cover.

Plug the USB plug into wall or computer USB socket.

Charging indicator will be on. Unplug the light after fully charged.

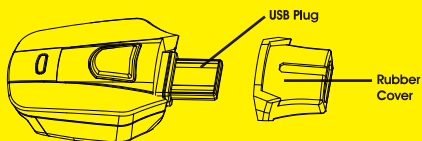

## MOUNTING

Attach strap to one bracket hook.

Pull strap over the post and attach to hook.

Place light on bracket, twist clockwise into the groove.

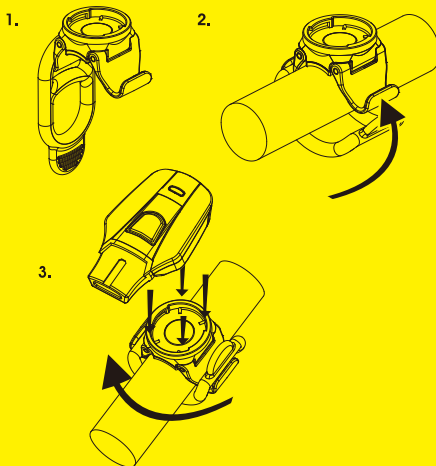

## AUTO SAFE MODE

To preserve battery when power is low, the light will enter low output flashing mode for 20mins. Safe mode cannot be override. Recharge the batteries for maximum performance.

## BATTERY CARE

- \* Do not charge over 5V, the battery will result in damage.
- \* Keep away from flammable objects while charging as this may lead to fire or battery explosion.
- \* Battery may get high temperatures during charging (up to 104°F/40°C)
- \* The battery capacity may become ineffective about 80% of its value after 300 charge/discharge cycles.
- \* The battery voltage and capacity decrease apparently at low temperatures, especially near or below ice point. The capacity decreases 5%-10% at freezing (burn time decreases 50%). At -20°C, the capacity decreases 30% (burn time decreases 70%). The battery performance will return normal when the temperature gets up to 70°F/20°C.
- \* Keep the battery in cool and dry place when storing. Recharge the battery fully at least every 3 months.

## WARNING

- \* Understand country lighting laws and regulations before use.
- \* Do not shine directly in the eyes.
- \* Do not submerge the battery or the whole light into water.
- \* Do not dismantle the light which will void warranty.
- \* Do not leave the light on and unattended.
- \* Keep the light away from fire and combustible materials.

## WARRANTY

MOON Lights are covered by a ONE YEAR LIMITED WARRANTY from the date of purchase is free from defects in material and workmanship. This warranty does not apply to damage due to heat, physical damage resulting from abuse, neglect, improper repair, improper fit, or alterations of the fixture. This covers the lights and cables only. Batteries are covered by 120 days warranty not including battery normal wear. .

For more information, please contact us at [cs@moon-sport.com](mailto:cs@moon-sport.com).