

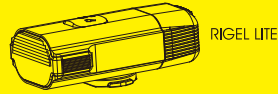

The light is locked for shipment, refer to OPERATION instruction to unlock. Read this manual carefully before using and keep for future reference. Visit www.moon-sport.com for manual updates.

CONTENTS



RIGEL LITE



RB-42
(MOON LIGHT ADAPTER
FOR GOPRO MOUNT)



RB-43
(HANDLEBAR BRACKET)

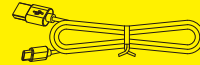

USB-C
(USB CABLE)

Optional accessories:

RB-41 (HELMET MOUNT)

USB-C-RM2020 (REMOTE CONTROL)

OPERATION

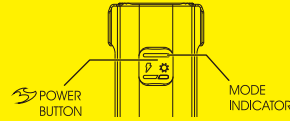

ON / OFF : Press 1s

MODE SELECT : Click

STEADY / FLASH : Double Click

LOCK/UNLOCK : 1. Power off

2. Press 6s: Locked FLASH 2 TIMES

Unlocked FLASH 2 TIMES

* Lock system: Lock the light to prevent accidentally turned on.

* Mode memory: The light resumes previous mode upon next usage.

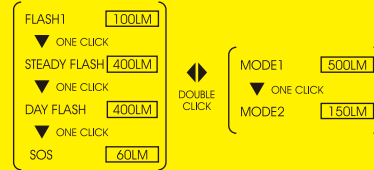

VARIABLE LUMEN SYSTEM



1. Select desired mode.
2. Press and hold to set lumen.
3. Release when reaching desired lumen.

* Light flashes twice when reaching

the MAX or MIN lumen level.

* Restore default mode: 1. Power off

2. Press 10s: FLASH 3 TIMES

RUNTIME

	ANSI FL1	MODE1	MODE2	FLASH1	STEADY FLASH	DAY FLASH	SOS
DEFAULT	LUMEN	500	150	100	400	400	60
	H:MIN	1:30	5:30	46:00	13:30	40:00	36:00
	VLS LUMEN	500-20	500-20	500-20	500-20	500-20	-
H:MIN	1:30-41:00	1:30-41:00	8:00-111:00	11:30-69:00	27:30-160:00	-	-

└─ DEPENDS ON MODE LUMENS ─┘

ROTATABLE ANTI-DAZZLING LENS

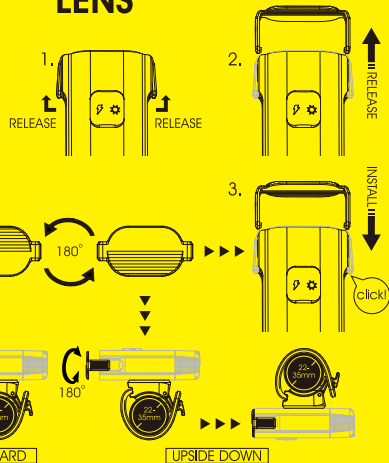

HANDLEBAR MOUNTING

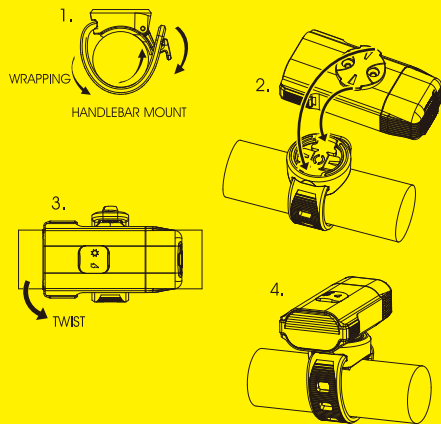

OVERHEAT PROTECTION

The overheat protection device can ensure the bicycle light in a good running temperature condition, so that to protect the LEDs without burning case. If the light is in high temperature during operation, it will dim the light output.

CHARGING

1. Power off.
2. Plug USB cable to USB port.
3. Unplug after fully charged.

* Do not charge over 5V.

* Keep away from flammable objects while charging.

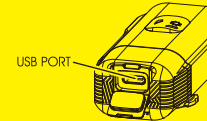

BATTERY CAPACITY AND CHARGING INDICATOR

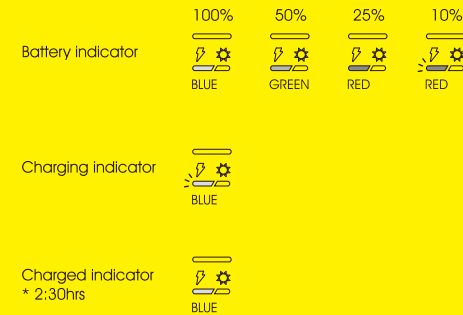

WARNING

- Understand country lighting laws and regulations before use.
- Do not shine light directly into eyes.
- Do not mount near wireless computer.
- Do not blind the oncoming vehicles. Always adjust the angle downward.
- Do not submerge the light into water.
- Keep light in cool and dry place when storing.
- Fully recharge the light at least every 3 months during storage.

WARRANTY

MOON lights are covered by a ONE YEAR LIMITED WARRANTY while MOON batteries are covered by 120 days warranty from the date of purchase. This warranty covers the defects in material and workmanship only with proof of purchase. Please contact original dealer for warranty service. For lights bought on MOON website, please contact cs@moon-sport.com for help.

ONLINE WARRANTY REGISTRATION

Visit www.moon-sport.com for online warranty registration.